

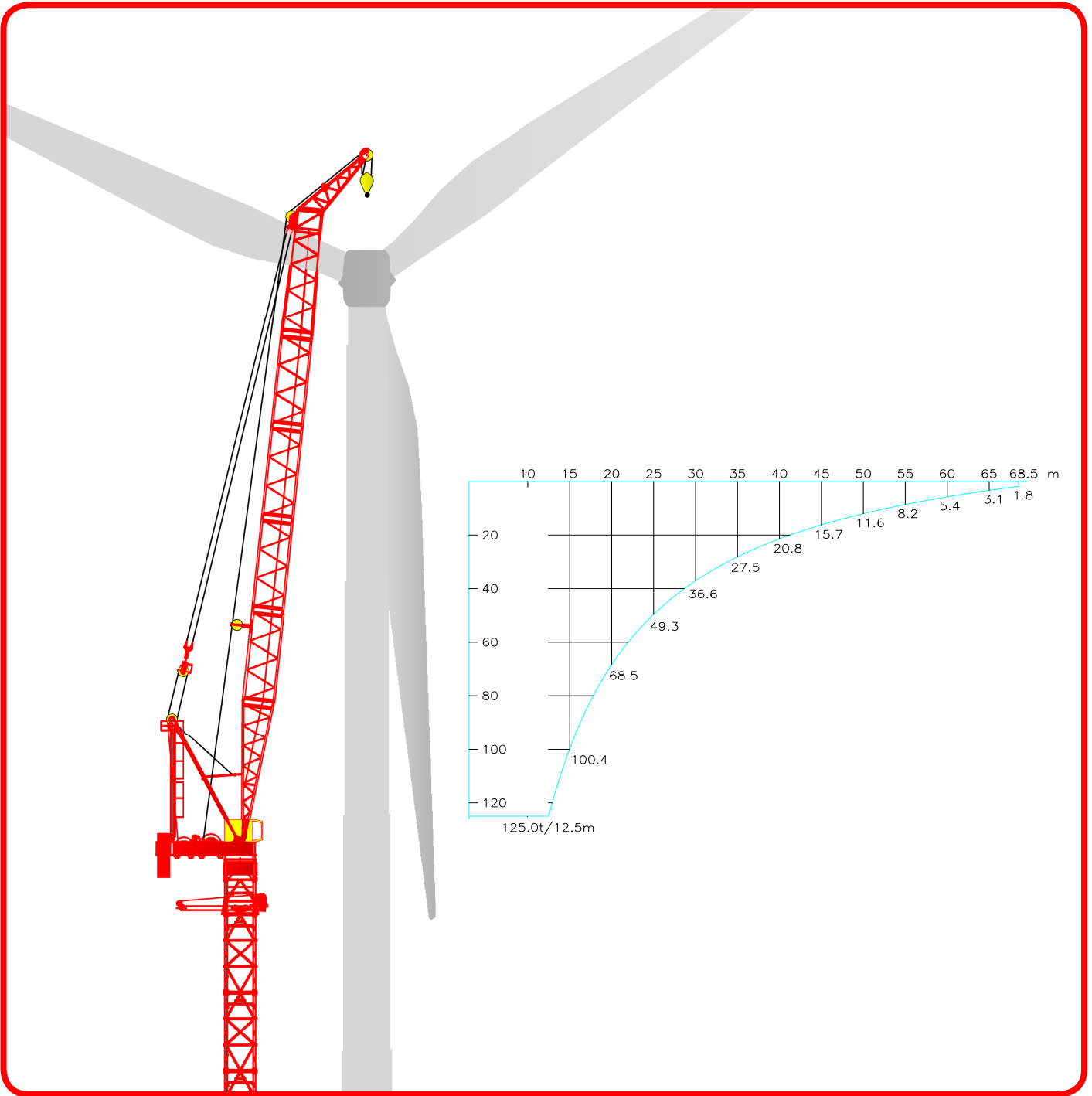

KRØLL CRANES



F.E.M 1.001-HC1/A3/E3



**LUFFING BOOM
TOWER CRANE**

K1500L

125 tonnes Max

ERECTED DIMENSIONS

Lifts above 60 tonnes are limited to 15 m/s wind speed

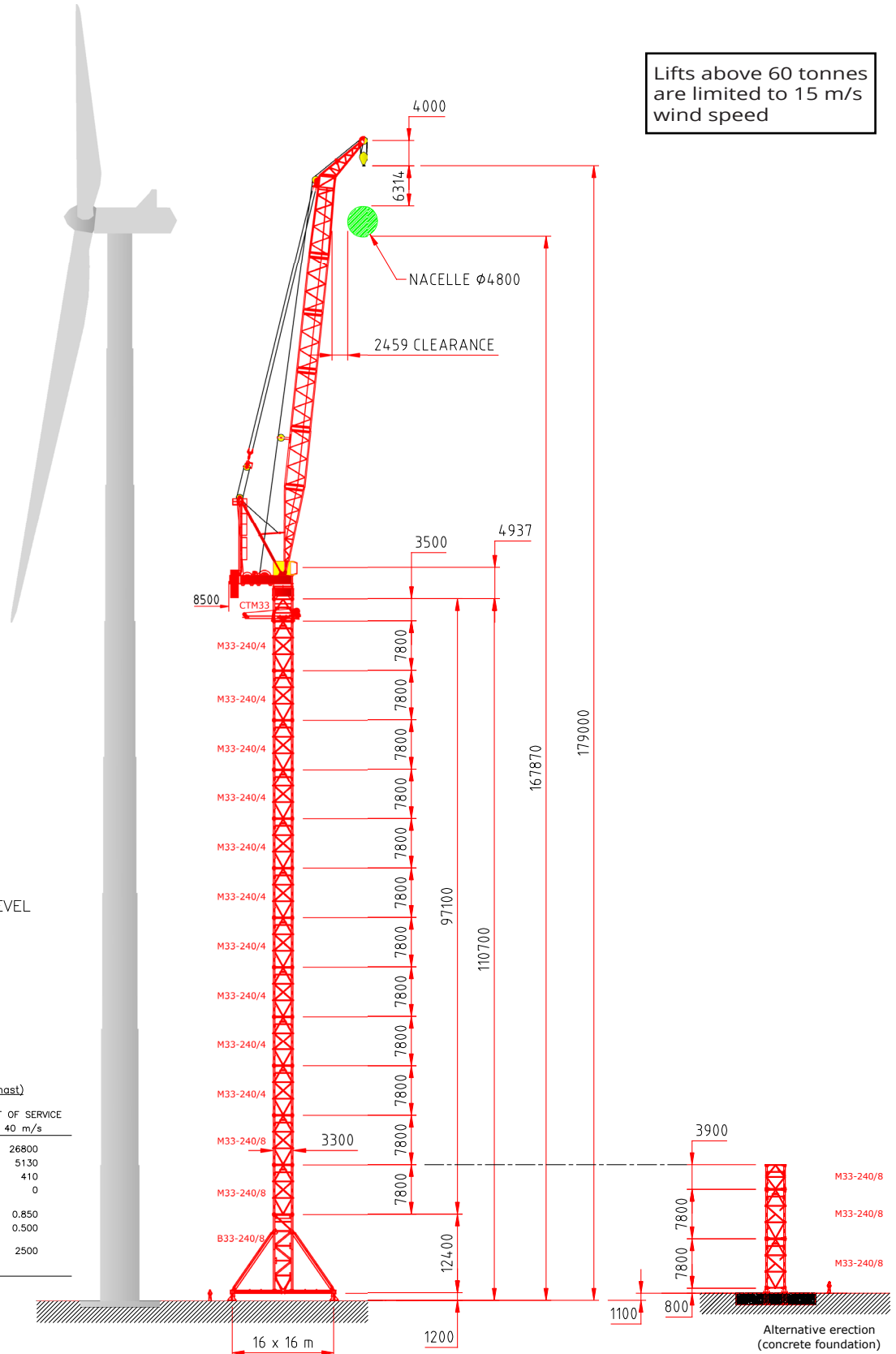

FORCES AT GROUND LEVEL

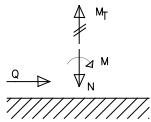







BASE FORCES, 167.0 m (109.8 m mast)

Wind speed	IN SERVICE	OUT OF SERVICE
	15 m/s	40 m/s
M (kNm)	27850	26800
N (kN)	6580	5130
Q (kN)	120	410
M_T (kNm)	800	0
Deflection, masth. (m)	1.500	0.850
Tilt, masth. (degrees)	1.100	0.500
Corner load (kN) 16x16m BX	3000	2500

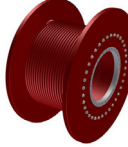
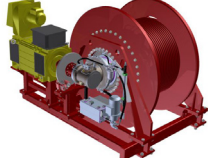
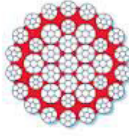

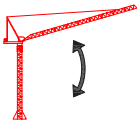
LOAD CHARTS

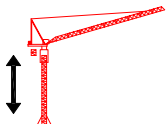
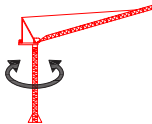
Radius	Boom Length	
	69.0 m	
	Boom Angle	4 parts
[m]	[Degrees]	[Kg]
10.1	86.0	125,000
12.5	84.0	125,000
15.0	81.9	100,400
17.5	79.8	82,100
20.0	77.6	68,500
22.5	75.3	57,800
25.0	73.3	49,300
27.5	71.0	42,400
30.0	68.8	36,600
32.5	66.5	31,700
35.0	64.1	27,500
37.5	61.7	23,900
40.0	59.2	20,800
42.5	56.6	18,100
45.0	54.0	15,700
47.5	51.2	13,500
50.0	48.3	11,600
52.5	45.3	9,800
55.0	42.0	8,200
57.5	38.5	6,700
60.0	34.7	5,400
62.5	30.5	4,200
65.0	25.4	3,100
67.5	18.6	2,200
68.5	15.0	1,800

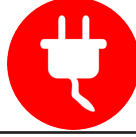
HOIST WINCH MOTOR 154 kW	4-PARTS 			HOIST DRUM CAPACITY 720 m / 7 layers		
		Load		Max. Speed		HOIST WIRE
0 - 10 t		22 m/min	Diameter	40 mm		
10 - 60 t		12 m/min	Safety Factor	4.6		
60 - 125 t	6 m/min	MBL	1560 kN			
	LUFFING WINCH MOTOR 90 kW			LUFFING DRUM CAPACITY 242 m / 5 Layer		
	LUFFING SPEEDS			LUFFING WIRE		
	Average	4:00 min	Diameter	32 mm		
			Safety Factor	4.7		
			MBL	930 kN		
	CT33 CLIMBER			SLEW DRIVE Motor 2 x 11 kW		
	CLIMBING SPEEDS			SLEW SPEEDS		
	1 tower section up or down	1:00 hr		0 - 35 m	0 - 0.5 rpm	
				SUPPLY CABLE		
	POWER SUPPLY 400 - 480 V, 50/60 Hz			Cable Length	Cable Type	
	Consumption	320 kVA		0 - 120 m	4 x 185 mm ²	
	Main Fuse	400 A				
	Recommended Generator Size	400 kVA				

All motion controls are completely stepless ensuring smooth and jerk-free operation.
Creeping speed down to 0.5% of maximum speed.

All specifications shown in the tables are for the standard version of K1500L. For special requirements regarding load charts or drive speeds, please contact Krøll Cranes A/S.

WEIGHTS & DIMENSIONS

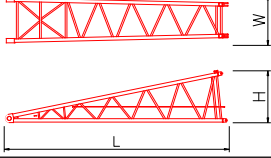
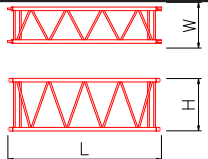
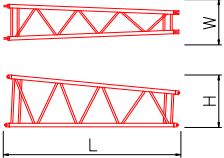
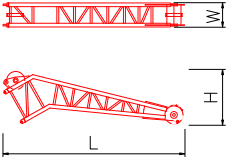
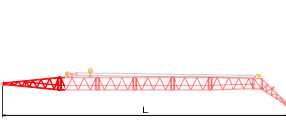
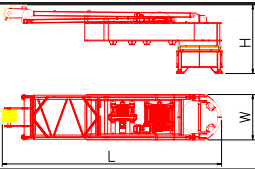
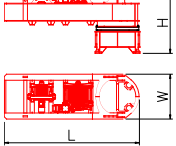
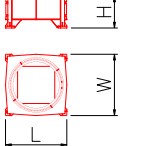
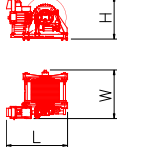
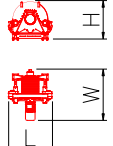
Component	Weight	Transportation Dimensions		
		Length	Width	Height
 <p>Boom Bottom Section</p>	6,500 kg	14.3 m	3.2 m	3.3 m
 <p>Boom Extension Section - 4 pcs</p>	4,000 kg	9.4 m	2.8 m	3.2 m
 <p>Boom Top Section</p>	5,000 kg	11.0 m	2.8 m	3.25 m
 <p>Boom Tip Section</p>	5,000 kg	10.75 m	1.45 m	3.3 m
 <p>Boom Assembly c/w Pendants</p>	32,500 kg	70.1 m		
 <p>Assembly Option 1 Deck, Slew Mount, Mast and Winches</p>	90,000 kg	14.7 m	3.3 m	5.0 m
 <p>Assembly Option 2 Deck, Slew Mount and Winches</p>	75,000 kg	9.95 m	3.3 m	4.5 m
 <p>Slew Mount</p>	9,500 kg	3.3 m	3.3 m	1.72 m
 <p>Hoist Winch + 800m Hoist Rope Total</p>	11,500 kg 6,400 kg 17,900 kg	3.97 m	3.15 m	2.76 m
 <p>Luffing Winch + 200m Luffing Rope Total</p>	5,000 kg 1,000 kg 6,000 kg	2.4 m	2.05 m	1.8 m

WEIGHTS & DIMENSIONS

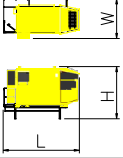
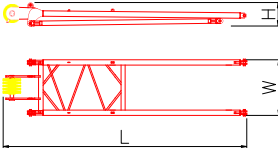
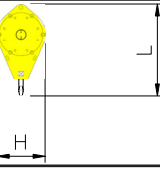
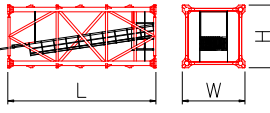
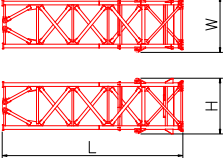
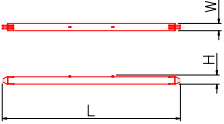
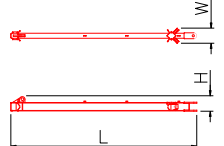
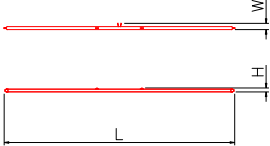
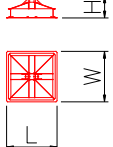
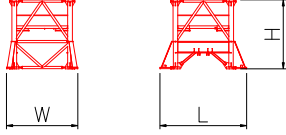
Component	Weight	Transportation Dimensions		
		Length	Width	Height
 <p>Operator's Cabin Assembly</p>	3,100 kg	4.6 m	2.395 m	3.15 m
 <p>Mast Assembly incl. access ladder & platform</p>	13,700 kg	12.8 m	3.21 m	1.35 m
 <p>Hook Block</p>	3,500 kg	2.4 m	1.25 m	0.7 m
 <p>M33 Tower Assembly</p>	15,000 kg	7.8 m	3.3 m	3.3 m
 <p>B33 Bottom Mast</p>	22,000 kg	11.9 m	3.67 m	3.67 m
 <p>B33 Support Legs - 4 pcs</p>	3,000 kg	12.43 m	0.508 m	0.630 m
 <p>Bottom Cross Beams - 4 pcs</p>	3,000 kg	11.07 m	0.9 m	0.9 m
 <p>Bottom Cross Side Beams - 2 pcs</p>	700 kg	15.41 m	0.415 m	0.19 m
 <p>Pyramid Base - 4 pcs</p>	3,000 kg	2.3 m	2.3 m	1.0 m
 <p>CTM33 Climbing Frame</p>	10,000 kg	4.4 m	3.62 m	3.5 m

WEIGHTS & DIMENSIONS

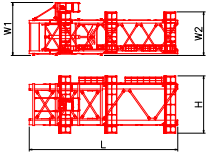
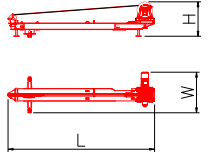
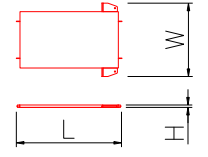
Component	Weight	Transportation Dimensions		
		Length	Width	Height
 <p>CT33 Climbing System</p>	33,000 kg	16.15 m	W1 = 5.76 m W2 = 4.74 m	6.23 m
 <p>Erection Beam & Winch</p>	6,000 kg	9.1 m	2.32 m	2.2 m
 <p>Counterweight - 11 pcs</p>	9,100 kg	5.04 m	3.06 m	0.1 m

NOTES

ERECTION SEQUENCE

1

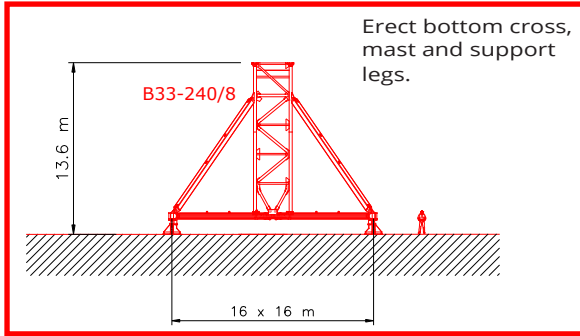

2

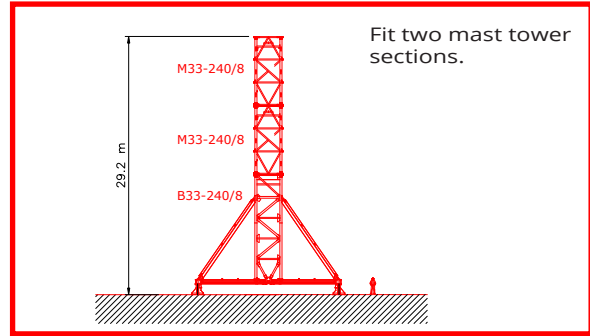

3

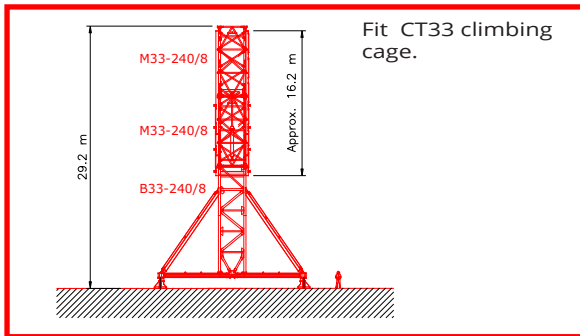

4

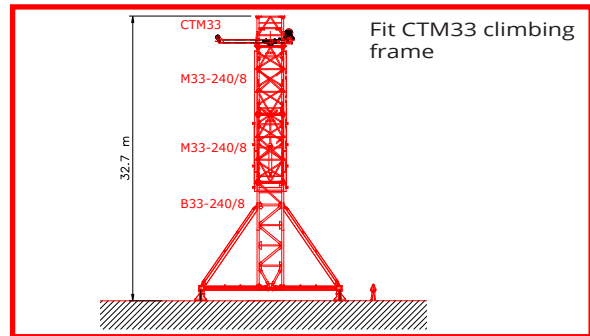

5

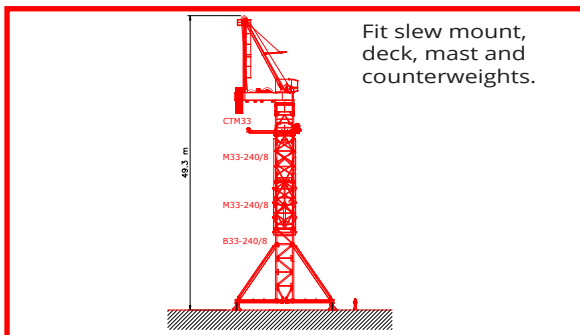

6

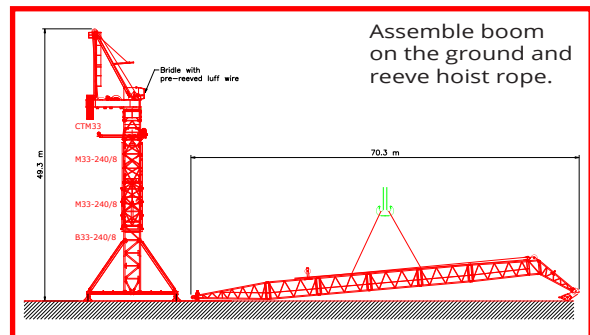

7

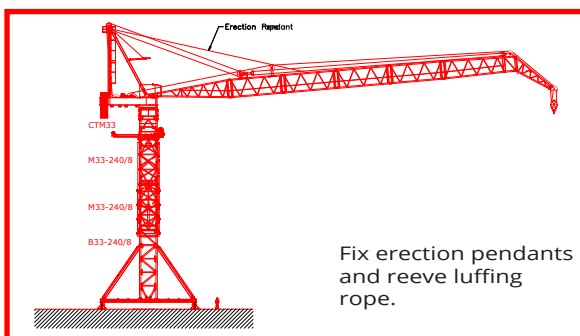

8

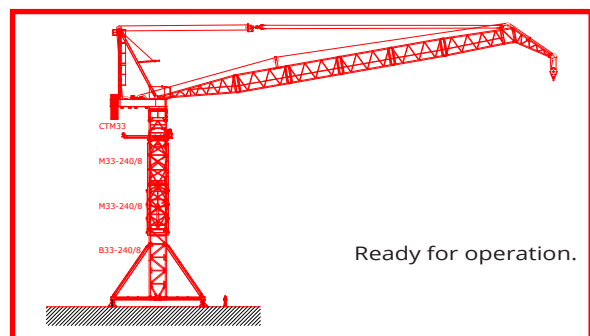

9

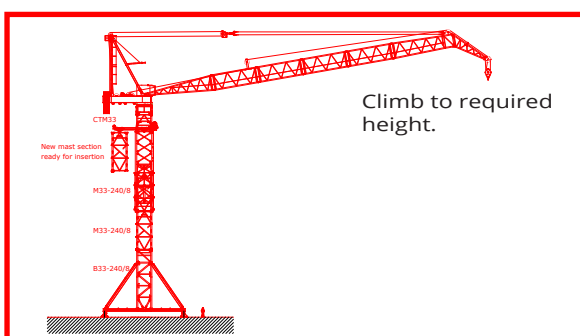

10

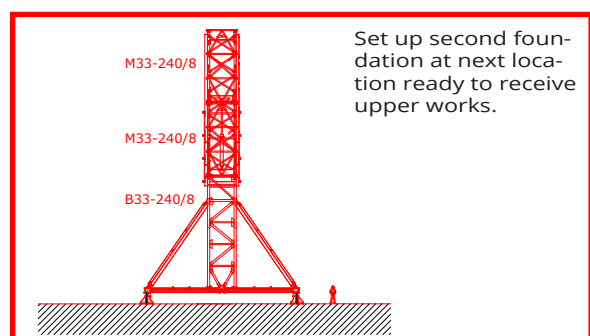

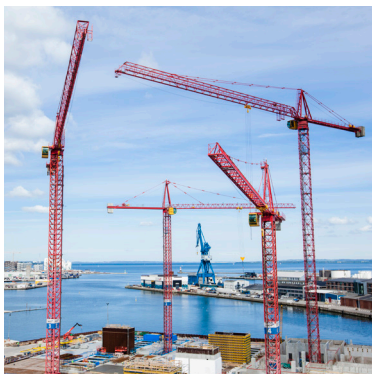
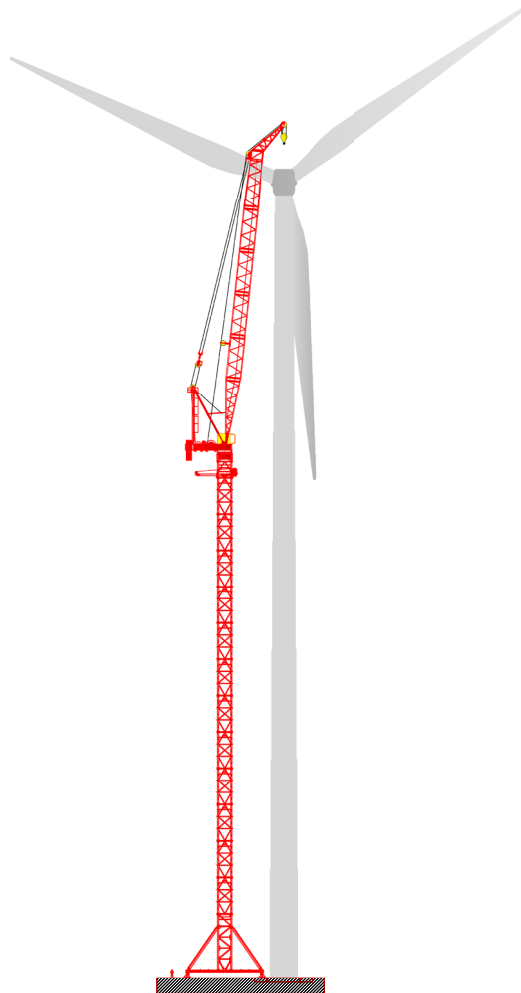

KRØLL CRANES A/S
Nordkranvej 2
DK-3540 Lyngø
Denmark

Tel: +45 48 18 74 00
Mail: info@krollcranes.dk
Web: www.krollcranes.dk

