

Pos. 21 Elektrik
 Pos. 23 Schildersatz

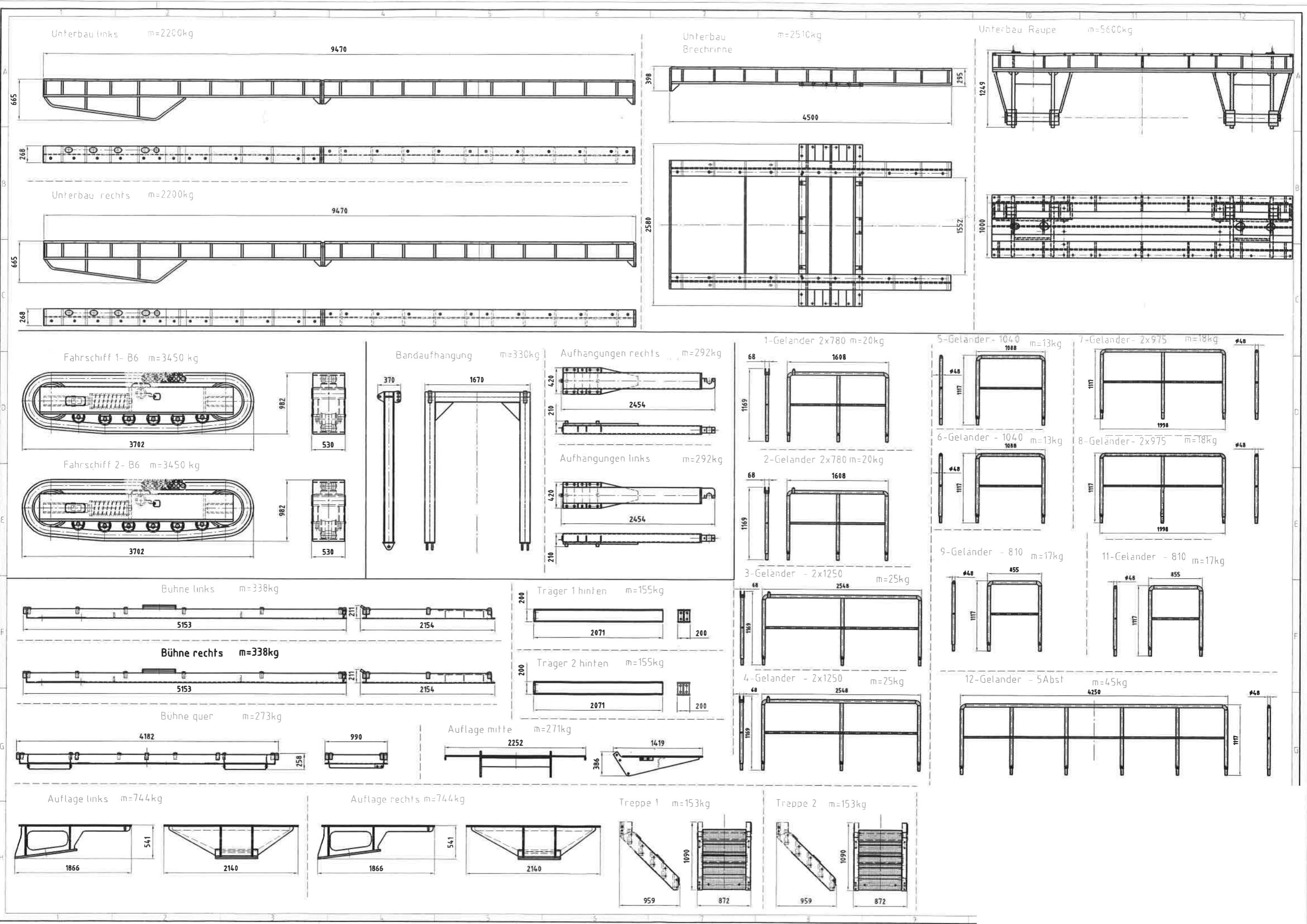

13-Geländer Treppe m=16kg

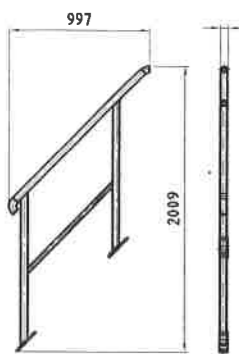

14-Geländer Treppe m=16kg

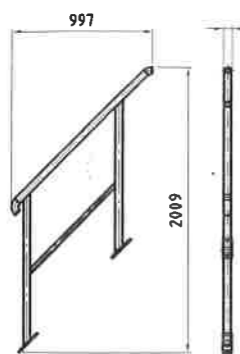

15-Geländer Treppe m=16kg

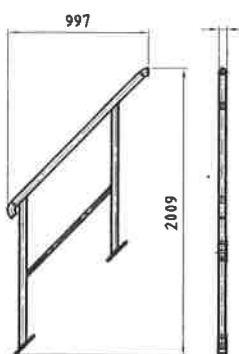

16-Geländer Treppe m=16kg

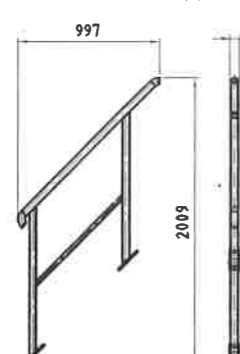

17-Geländer 2x1120 m=23kg

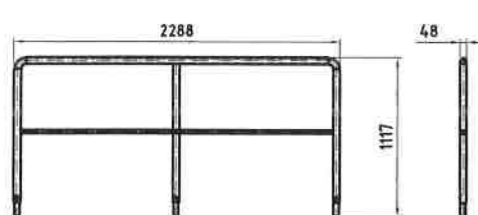

Abdeckung m=19kg

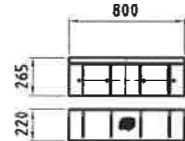

Bügel 1 m=16kg

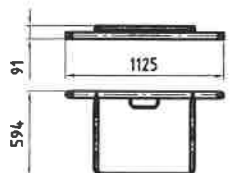

Bügel 2 m=16kg

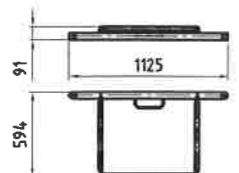

10 Roste 1940x995 m=940kg

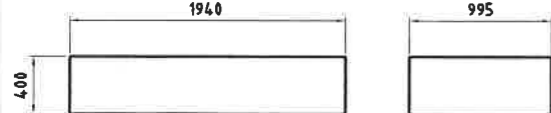

2 Roste 850x885 m=74kg

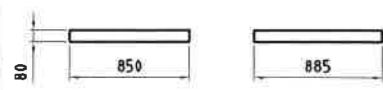

2 Roste 810x1020 m=85kg

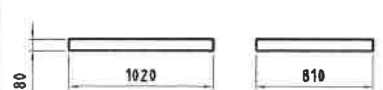

Leiter 1 m=7kg

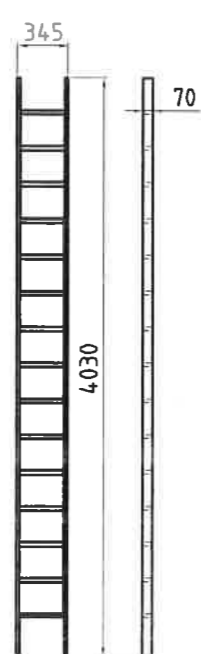

Leiter 2 m=7kg

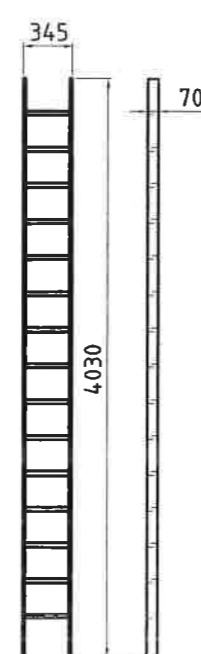

Halter m=????kg TB03-LP01

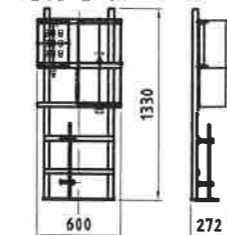

Halter Ampel m=????kg

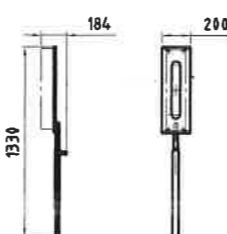

Halter SPAL 2x50,8+2x38 m=11kg

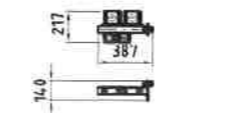

Halter längs m=108kg

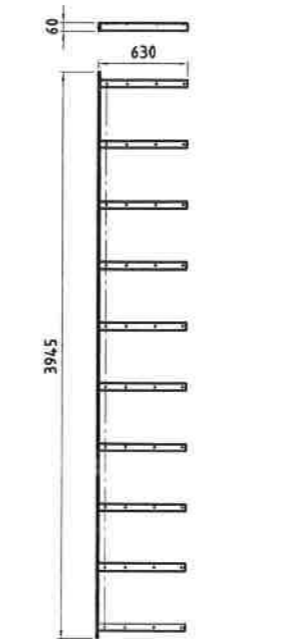

Halter 1 m=34kg SPAL

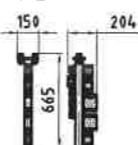

Halter 2 m=34kg SPAL

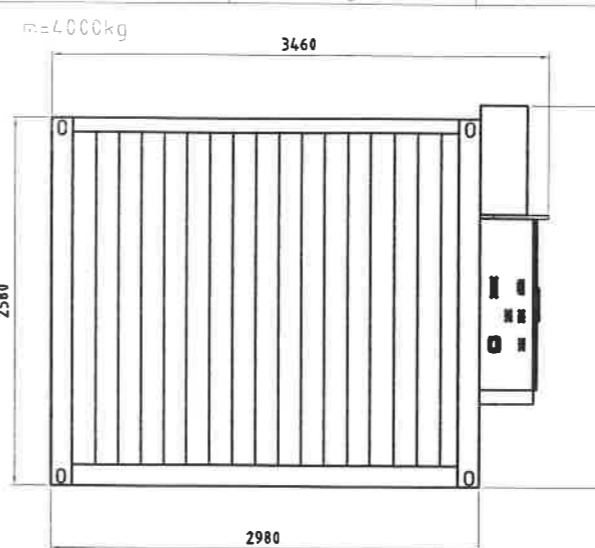
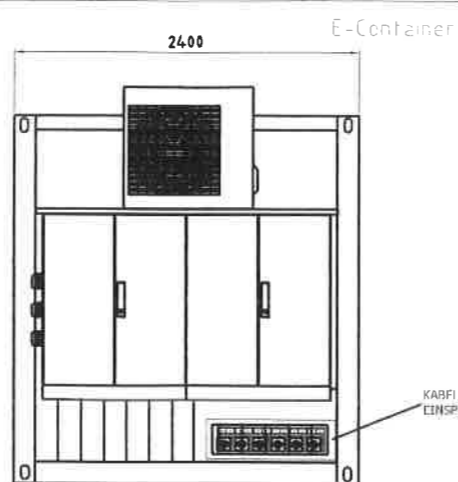
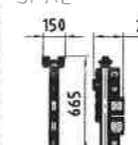

Kiste 1 Zubehör m=186kg

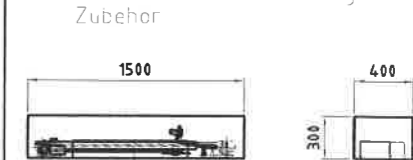

Palette Schlagelmente m=100kg

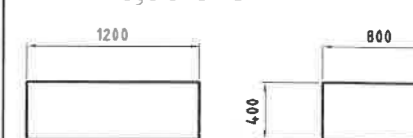

Kiste 2 Demontage m=400kg

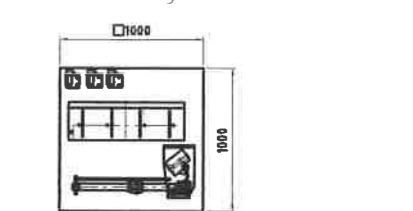

Kiste 3 Elektrik 1 m=300kg

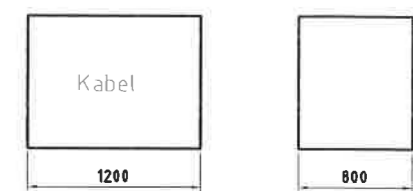

Kiste 4 Elektrik 2 m=300kg

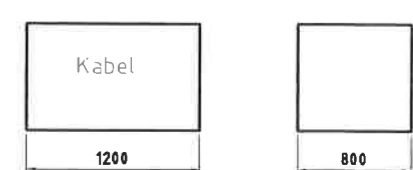

Kiste 5 Elektrik 3 m=200kg



Kiste 6 Elektrik 4 m=300kg



Kehre + 2 Rinnen m=2524,9kg

12825

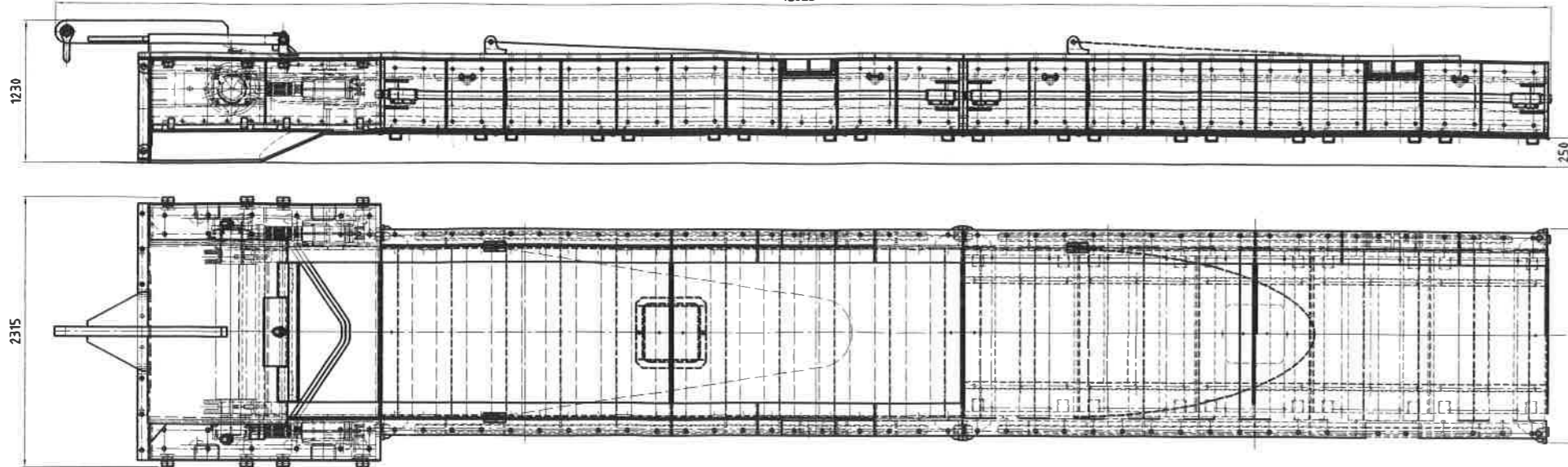

Einlaufhaube m=3850kg

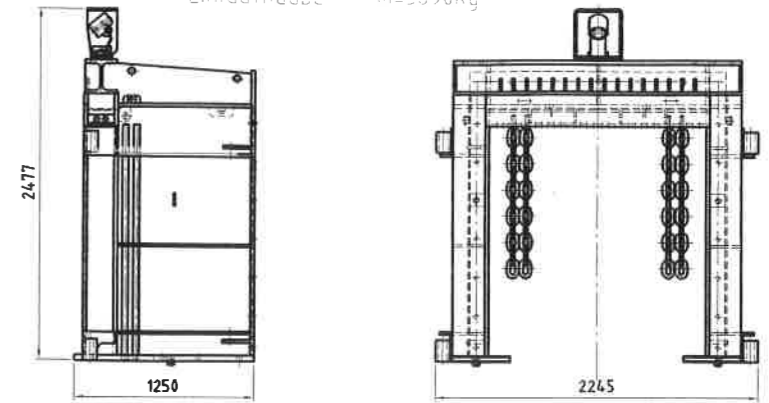

Ausstellbracke links m=1407kg

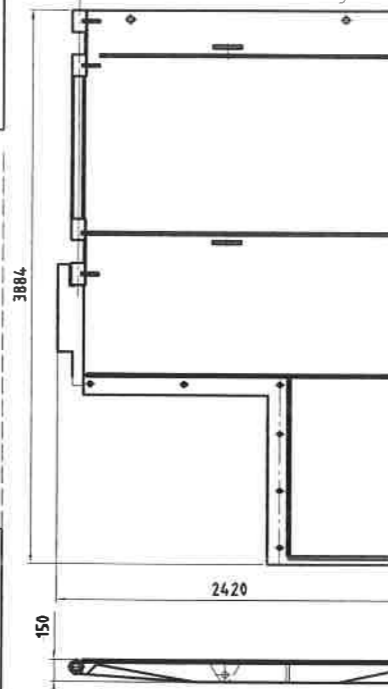

Ausstellbracke rechts m=1407kg

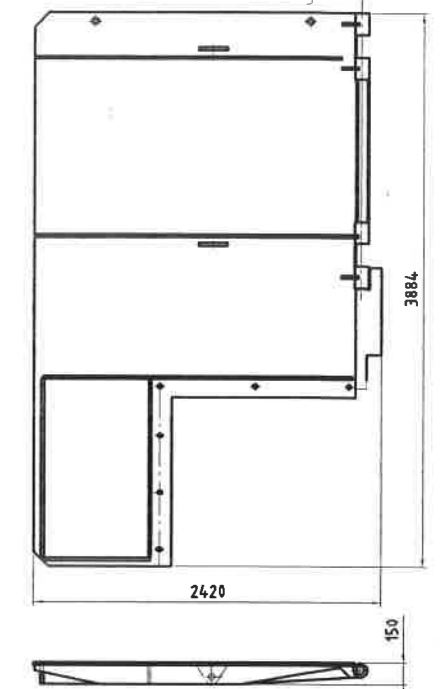

Brechergeh + Walz+Brecherrinne + Antriebsr m=23685kg

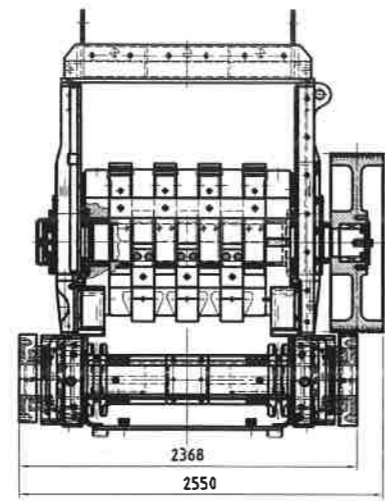
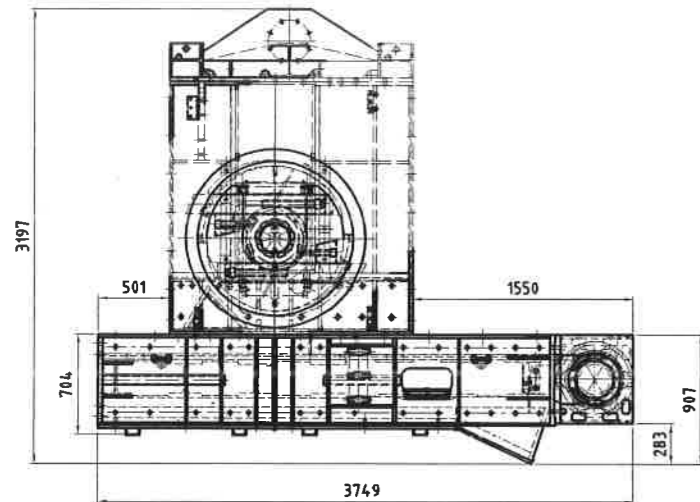

Haube Raupenschiffe m=2733kg

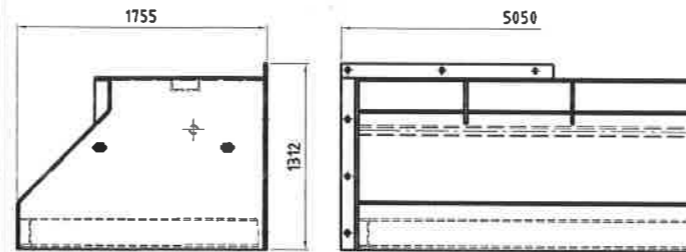

Keilriemenschutzhaube m=970kg

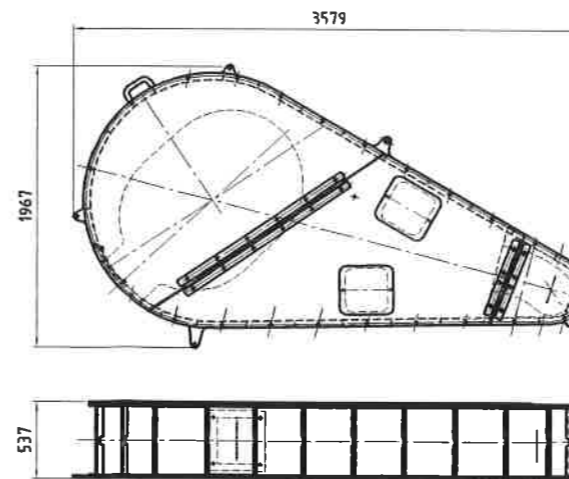

Förderer-Antrieb m=4640kg

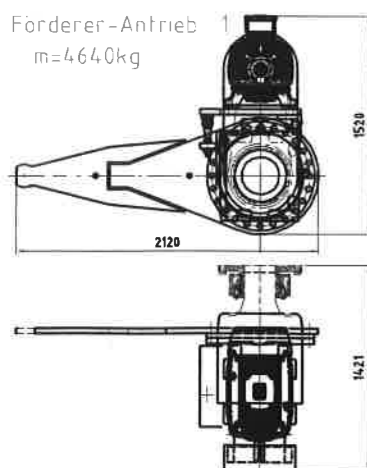

Förderer-Antrieb 2 m=4640kg

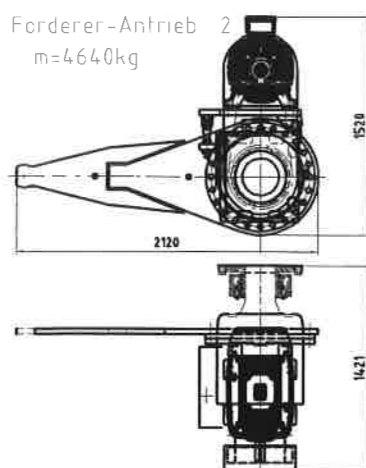

Schmierschrank m=240kg

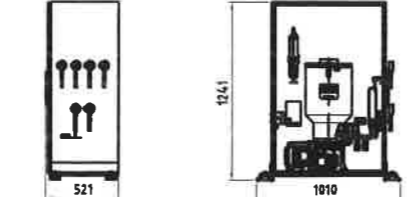

Hydraulikschrank m=130kg

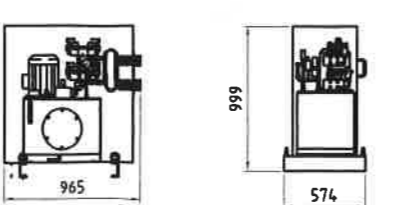

Abwurfhaube + Walzenmotor m=6822kg

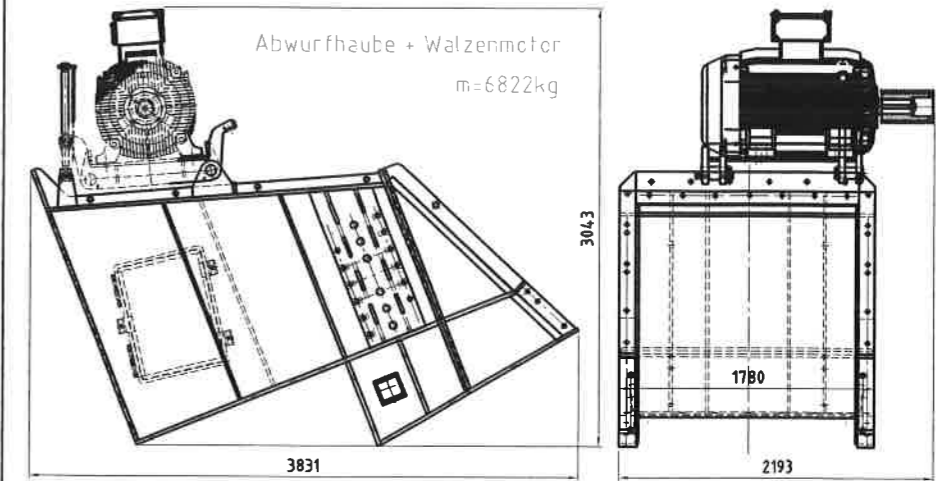

Schutzhaube 1 m=85kg

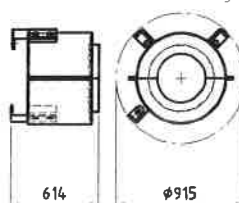

Schutzhaube 2 m=85kg

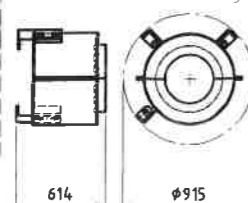

Momentenstütze m=130kg

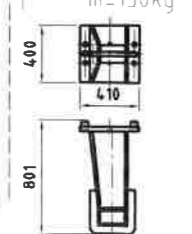

Momentenstütze 2 m=130kg

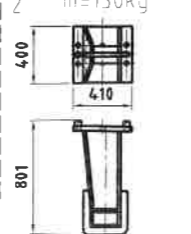

Abwurftrichter m=945kg

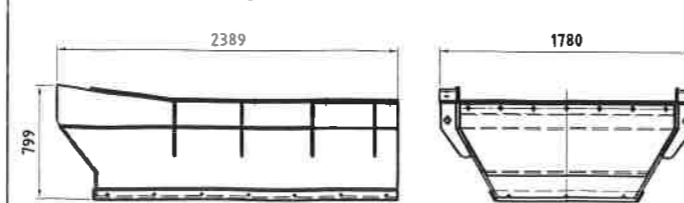

Kettenband m=9620kg

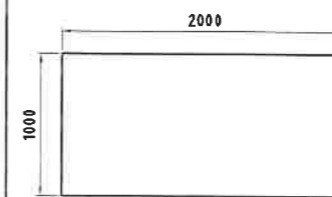

ca 4000mm lang